

# Spare Parts for Agricultural Equipments

## PLOUGH BLADES SPARE PARTS

PULLUK BIÇAKLARI  
YEDEK PARÇALARI

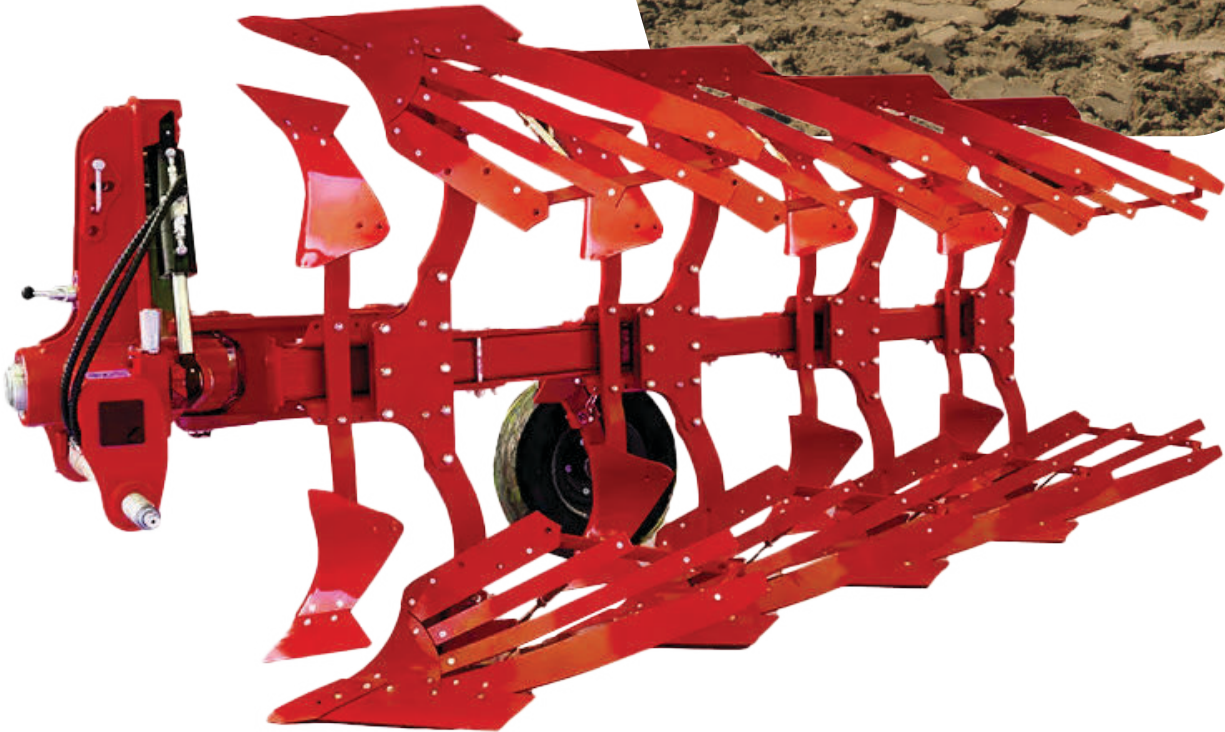

# 1 Plow Blades/Pulluk Bıçakları

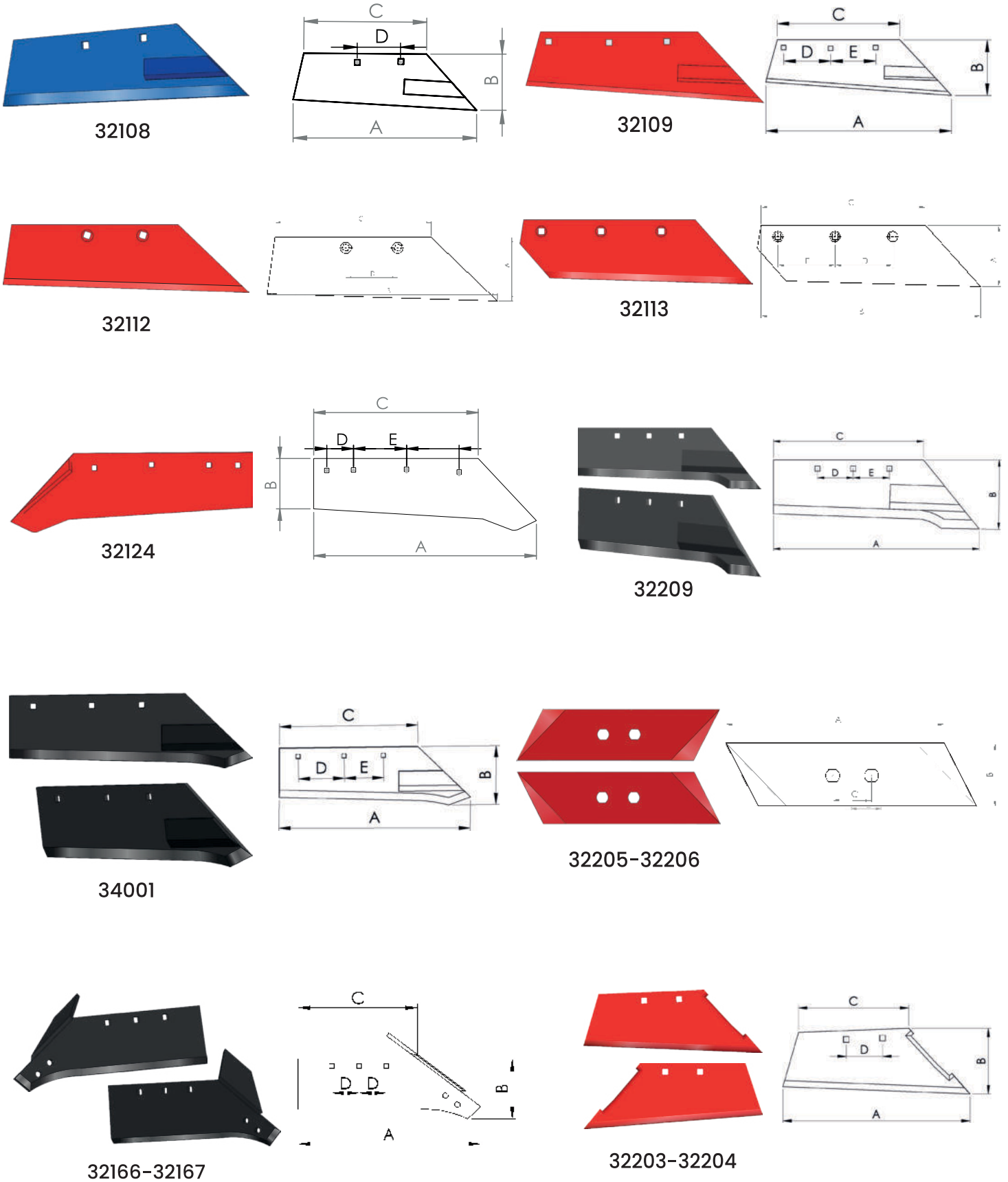

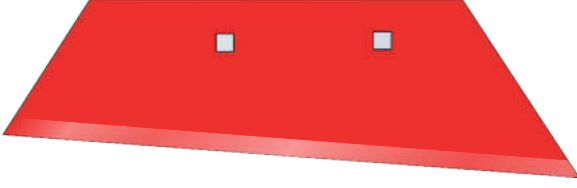

TOMA VINKOVIC PULLUK BIÇAĞI / IK-YD-30-32246



RAONIK ROS – CEVASTI PULLUK BIÇAĞI / IK-YD-30-32244

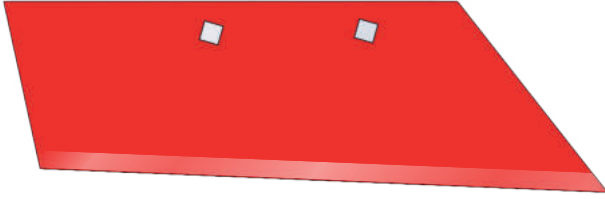

RAONIK – DUBICA PULLUK BIÇAĞI / IK-YD-30-32242

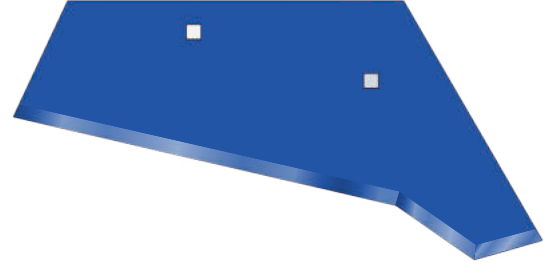
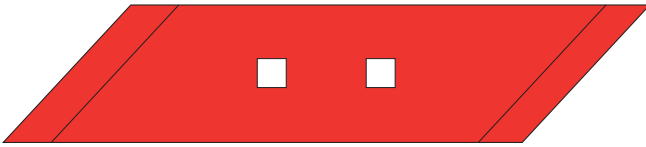
RAONIK OLT SLOVAK  
ALKAR 2 PULLUK BIÇAĞI / IK-YD-30-32243

IZMENJIVI VRH S.O / IK-YD-30-34000



KUHN PULLUK BIÇAĞI / IK-YD-30-32151

ÜRÜN KODU	ÜRÜN İSMİ	A	B	C	D	E	DELİK ÇAPI(mm)	KALINLIK(mm)
PRODUCT CODE	PRODUCT NAME	mm	mm	mm	mm	mm	HOLE DIAMETER(mm)	THICKNESS(mm)
IK-YD-30-32112	VİNİTSA 2 DELİK PULLUK BIÇAĞI	129	468	317	106	-	13	10
IK-YD-30-32113	VİNİTSA 3 DELİK PULLUK BIÇAĞI	128	484	360	126	125	13	10
IK-YD-30-32109	IMT 755 PULLUK BIÇAĞI	522	155,5	345	132	126,5	13	10
IK-YD-30-32124	IMT 757 PULLUK BIÇAĞI	641	145	474	77	153	13	10
IK-YD-30-32108	ROANIK PULLUK BIÇAĞI 2 DELİK	449	137	300	106,5	-	13	10
IK-YD-30-32166	KULAKLI PULLUK BIÇAĞI SOL	500	165	327	75	75	13	12
IK-YD-30-32167	KULAKLI PULLUK BIÇAĞI SAĞ	500	165	327	75	75	13	12
IK-YD-30-32209	LEMKEN PULLUK BIÇAĞI 1	518	174	378	90	91	13	10
IK-YD-30-34001	LEMKEN PULLUK BIÇAĞI 2	560	174	405	134,7	115	13	10
IK-YD-30-32203	ÜZÜM ARASI SAĞ	360	126	212	70	-	13	7
IK-YD-30-32204	ÜZÜM ARASI SOL	360	126	212	70	-	13	7
IK-YD-30-32205	KEVERLAND SAĞ NO 13	270	67	41	-	-	13	12
IK-YD-30-32206	KEVERLAND SOL NO 14	270	67	41	-	-	13	12

## 2 Moldboards/Aynalar

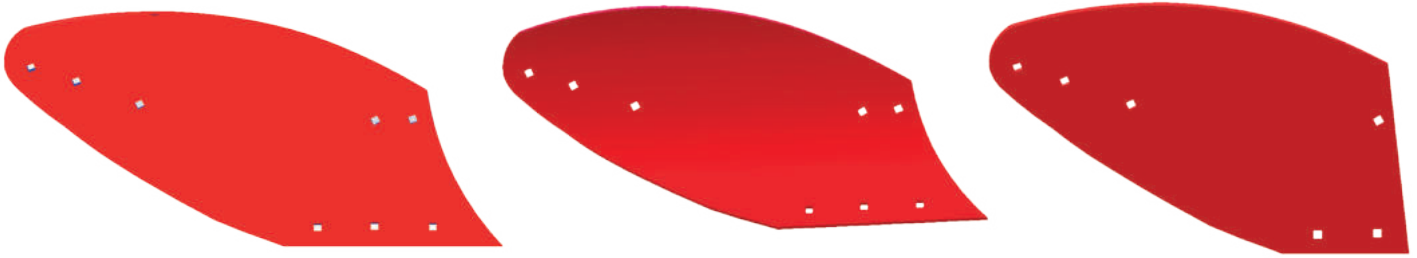

33100

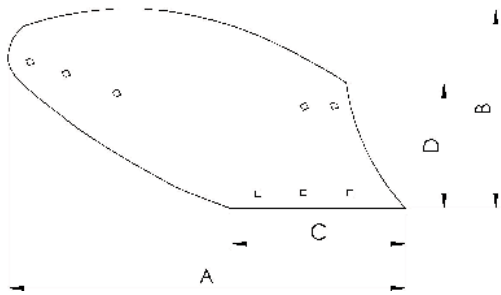

32110

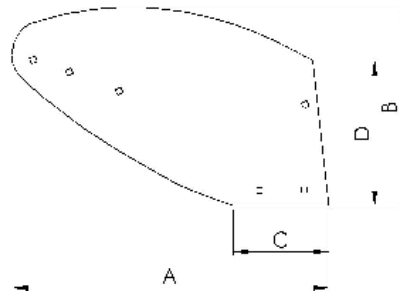

32111

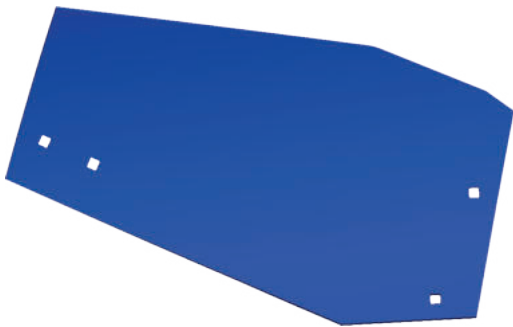

32172

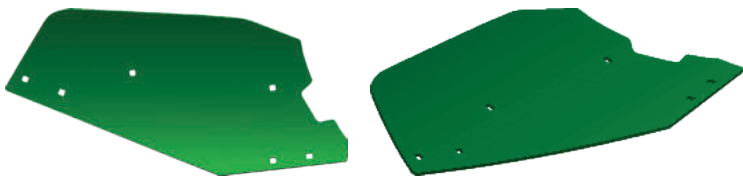
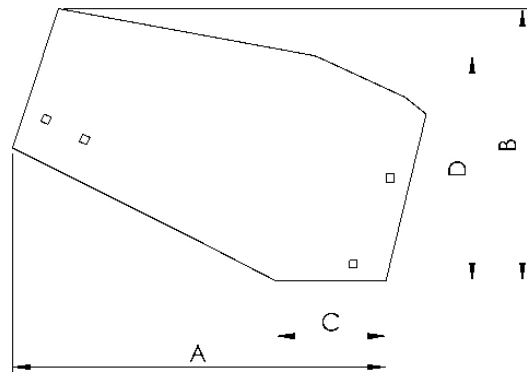

Lemken  
34020

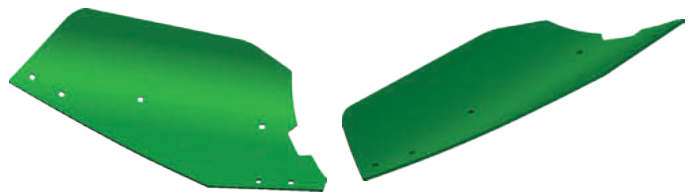

Lemken  
34021

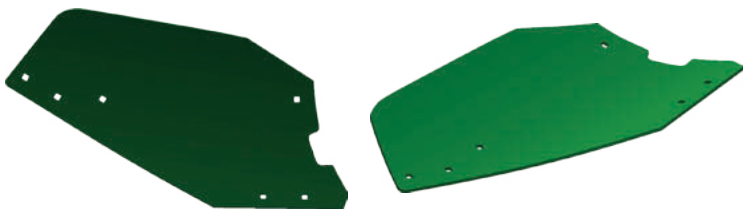

Lemken  
34022

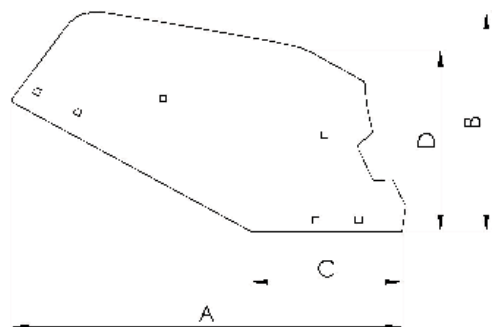



PREVERTAC - DEFLEKTOR LEOPARD  
IK-YD-30-32239

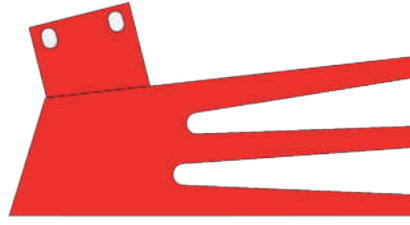

PREVERTAC - DEFLEKTOR IMT 757  
IK-YD-30-32241

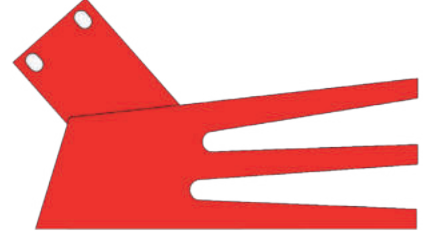

PREVERTAC - DEFLEKTOR IMT 755 - 6  
IK-YD-30-32240

ÜRÜN KODU	ÜRÜN İSMİ	A	B	C	D	DELİK ÇAPI(mm)	KALINLIK(mm)
PRODUCT CODE	PRODUCT NAME	mm	mm	mm	mm	HOLE DIAMETER(mm)	THICKNESS(mm)
IK-YD-30-32110	DASKA IMT 755 (RIGHT-LEFT)	866	433	380	273,5	13	7
IK-YD-30-32111	DASKA IMT 755 HALF PART (RIGHT-LEFT)	694	433,5	210	317,5	13	7
IK-YD-30-33100	DASKA IMT 757 (RIGHT-LEFT)	901	369	497	269	13	7
IK-YD-30-34020	Lemken NO 8 AYNA (RIGHT-LEFT)	774	435	298,5	361	13	8
IK-YD-30-34021	Lemken NO 9 AYNA (RIGHT-LEFT)	822,5	506	305,5	423	13	8
IK-YD-30-34022	Lemken NO 10 AYNA (RIGHT-LEFT)	812	493	317	420	13	8
IK-YD-30-32172	Lemken NO 11 AYNA (RIGHT-LEFT)	683	500	200	414	13	7

### 3 Moldboard Wear Part/Ayna Aşınma Parçaları

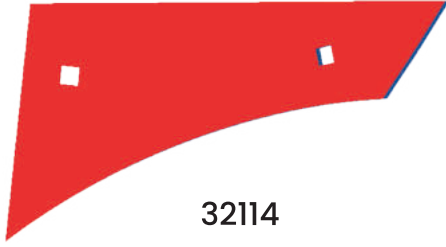

32114

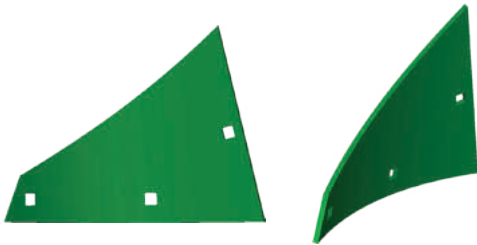
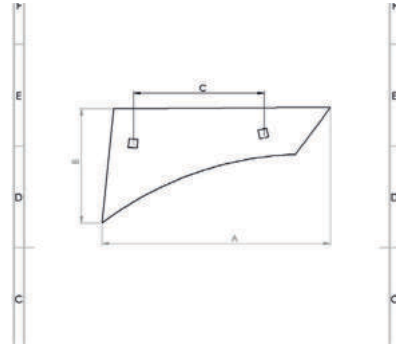

32162

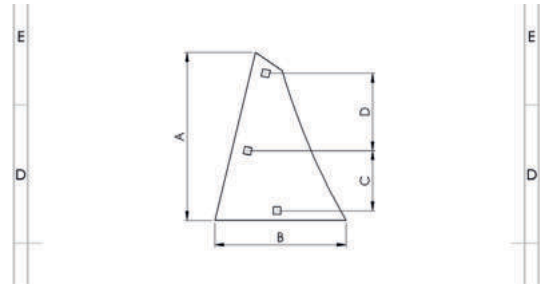

ÜRÜN KODU	ÜRÜN İSMİ	A	B	C	D	DELİK ÇAPI(mm)	KALINLIK(mm)
PRODUCT CODE	PRODUCT NAME	mm	mm	mm	mm	HOLE DIAMETER(mm)	THICKNESS(mm)
IK-YD-30-32162	Reonik Lemind Lescove Aşınma Parçası (RIGHT-LEFT)	303,5	237,7	108,5	140	13	8
IK-YD-30-32114	Doska Kulak Aşınma Parçası (RIGHT-LEFT)	319,5	169	192	-	13	7

# CULTIVATORS

Kültivatörler •



## 1 Chisel Shovel /Çizel Kürek



32177

ÜRÜN KODU	ÜRÜN İSMİ	A	B	C	DELİK ÇAPI(mm)	KALINLIK(mm)
PRODUCT CODE	PRODUCT NAME	mm	mm	mm	HOLE DIAMETER(mm)	THICKNESS(mm)
İK-YD-30-32177	ÇİZEL KÜREK ÜÇGEN	201	197	59,6	13	7

## 2 Crow's Feet /Kaz Ayakları

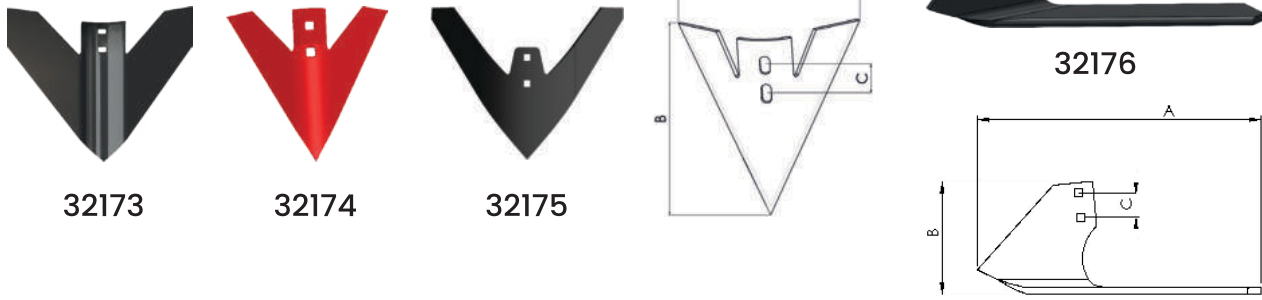

32173

32174

32175

32176

ÜRÜN KODU	ÜRÜN İSMİ	A	B	C	DELİK ÇAPI(mm)	KALINLIK(mm)
PRODUCT CODE	PRODUCT NAME	mm	mm	mm	HOLE DIAMETER(mm)	THICKNESS(mm)
İK-YD-30-32173	38 LİK 5 MM KÜLTÜR VATÖR	380	224	43	13	5
İK-YD-30-32174	28 LİK 7 MM KÜLTÜR VATÖR	283	255,5	48	13	7
İK-YD-30-32175	40 LİK 4 MM KÜLTÜR VATÖR	204	273	46	13	4
İK-YD-30-32176	KANATLI KAZ AYAĞI (SAĞ-SOL)	405	150	35	13	4

## 3 Snake Tongue/Yılan Dili

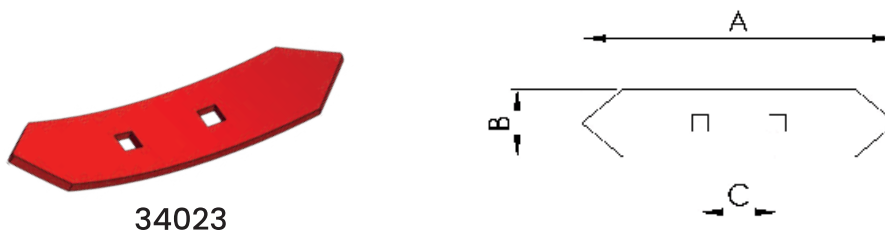

34023

ÜRÜN KODU	ÜRÜN İSMİ	A	B	C	DELİK ÇAPI(mm)	KALINLIK(mm)
PRODUCT CODE	PRODUCT NAME	mm	mm	mm	HOLE DIAMETER(mm)	THICKNESS(mm)
İK-YD-30-34023	AYSAN İKİ DELİKLİ	235	51	58	13	6

# HEADER BLADES

Çapa Bıçakları •





32178

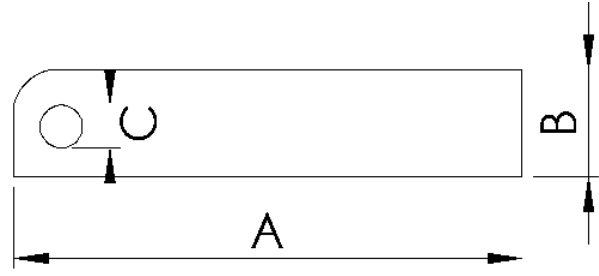

33010

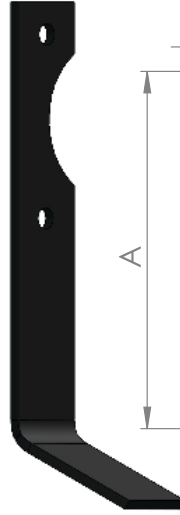
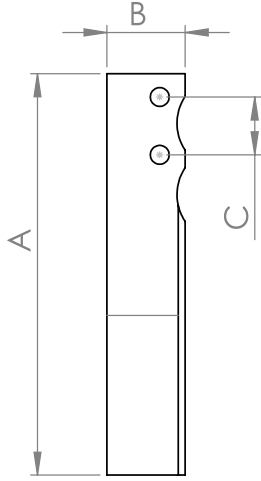

33011

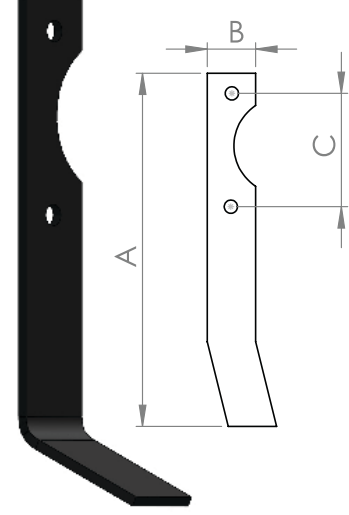
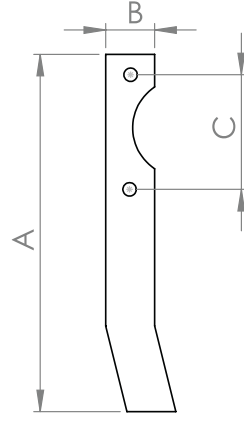

33012

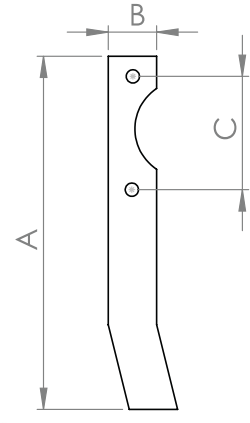
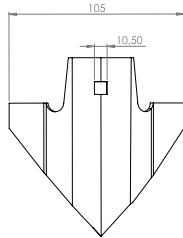
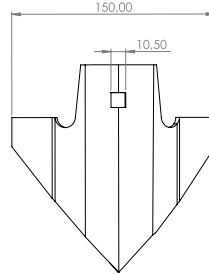
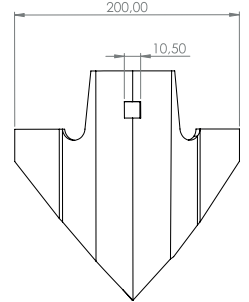
10.5 CM LİK ÖN PATİK  
İK-YD-30-3222815 CM LİK ÖN PATİK  
İK-YD-30-3222920 CM LİK ÖN PATİK  
İK-YD-30-32230

18 LİK TİLLER PATİK / İK-YD-30-32219

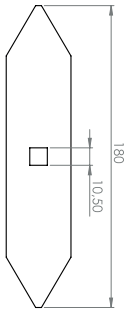

19 LÜK TİLLER PATİK / İK-YD-30-32245

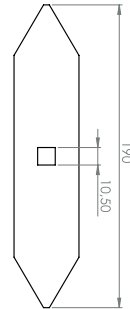

25 LİK TİLLER PATİK / İK-YD-30-32220

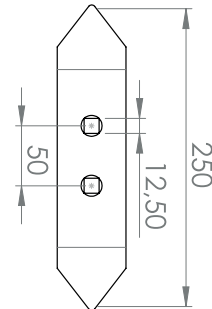
NOZ SEÇKE 3 MM  
İK-YD-30-32227

ÜRÜN KODU	ÜRÜN İSMİ	A	B	C	DELİK ÇAPI(mm)	KALINLIK(mm)
PRODUCT CODE	PRODUCT NAME	mm	mm	mm	HOLE DIAMETER(mm)	THICKNESS(mm)
İK-YD-30-32178	SİP EL SAP PARÇALAMA (SAĞ-SOL)	240	50	20	12	6
İK-YD-30-33010	LOMBARDİNİ EL ÇAPASI (SAĞ-SOL)	231	45	33,5	10,5	5
İK-YD-30-33011	İMT 504 EL ÇAPASI (SAĞ-SOL)	180	30	70	8,5	4
İK-YD-30-33012	İMT 506 EL ÇAPASI(SAĞ-SOL)	190	30	70	8,5	4

# ROTOVATOR BLADES

Rotovator Bıçakları





32179



32180



32181



32182



32183



32184



32185



32186



32187



32188



32189



32190



33111

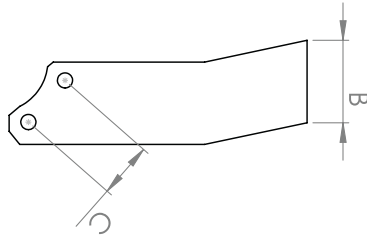

33112

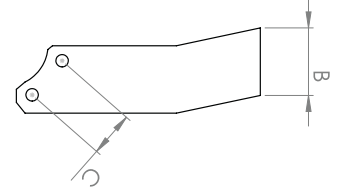

32191

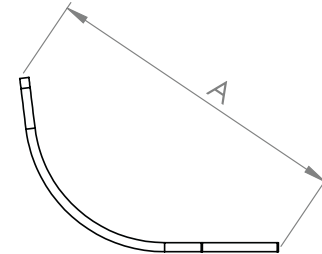

ÜRÜN KODU	ÜRÜN İSMİ	A	B	C	DELİK ÇAPı(mm)	KALINLIK(mm)
PRODUCT CODE	PRODUCT NAME	mm	mm	mm	HOLE DIAMETER(mm)	THICKNESS(mm)
İK-YD-30-32179	İKİLER BATUJA BLADES (RIGHT-LEFT)	201	76	52	14,5	7
İK-YD-30-32180	İKİLER TV NOVA TYPE BLADES (RIGHT-LEFT)	165	60	42	13	6
İK-YD-30-32181	İKİLER MURATORI TYPE BLADES (RIGHT-LEFT)	177	70	45	13	6
İK-YD-30-32182	İKİLER TV95 TYPE BLADES (RIGHT-LEFT)	175	60	42	12	6
İK-YD-30-32183	İKİLER TV830 TYPE BLADES (RIGHT-LEFT)	184	55	42	12,5	6
İK-YD-30-32184	İKİLER BREVIGLIERI TYPE BLADES (RIGHT-LEFT)	185	60	40	13	6
İK-YD-30-32185	İKİLER GREMEGNA TYPE BLADES (RIGHT-LEFT)	210	80	55	13	7
İK-YD-30-32186	İKİLER BREVIGLIERI TYPE 2 BLADES (RIGHT-LEFT)	185	70	40	12,5	7
İK-YD-30-32187	İKİLER IMT BATUJA TYPE BLADES (RIGHT-LEFT)	190	80	58	13	7
İK-YD-30-32188	İKİLER MASCHIO TYPE BLADES (RIGHT-LEFT)	187	70	40	12,5	6
İK-YD-30-32189	İKİLER BULGARIAN TYPE BLADES (RIGHT-LEFT)	181	78	55	13	7
İK-YD-30-32190	İKİLER MASCHIO TYPE 2 BLADES (RIGHT-LEFT)	195	70	43,7	14,5	6
İK-YD-30-32191	İKİLER NARDI 4C-5012 TYPE BLADES (RIGHT-LEFT)	148	75	55	13	7
İK-YD-30-33111	İMT 509 MİNİ ROTOVATÖR (RIGHT-LEFT)	165	56	37	11	5
İK-YD-30-33112	DMB MİNİ ROTOVATÖR (RIGHT-LEFT)	155	56	37	11	4

# 1 Lemken Plow Blades / Lemken Pulluk Bıçakları

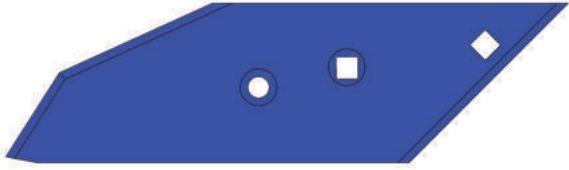

İKİLER LEMKEN ÖN PARÇA / IK-YD-30-32226

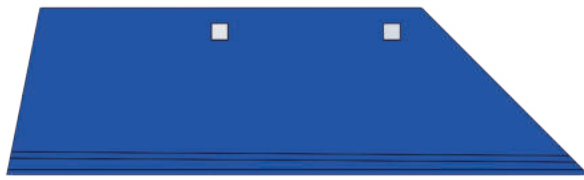
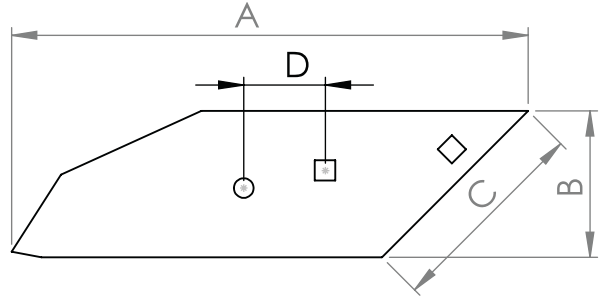

İKİLER LEMKEN ARKA PARÇA / IK-YD-30-32222

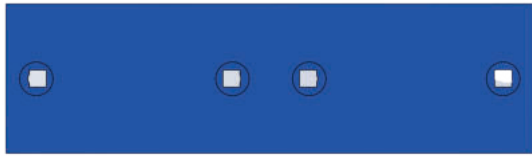
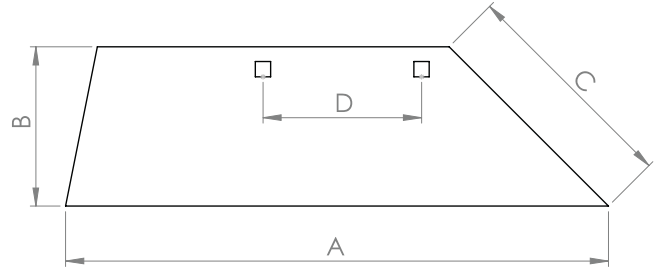

İKİLER LEMKEN KISA TABAN / IK-YD-30-32225

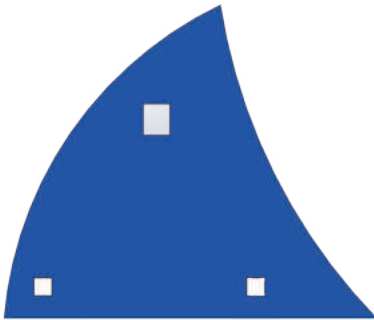
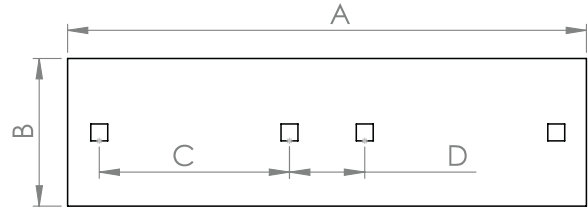

İKİLER LEMKEN AŞINMA PARÇASI / IK-YD-30-32223

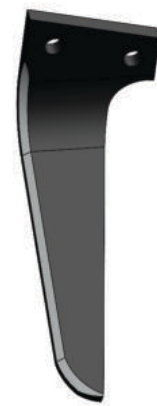
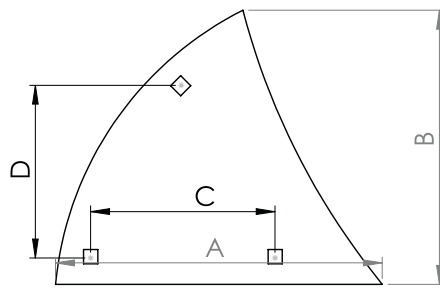

İKİLER LEMKEN DİK FREZE  
IK-YD-30-32224

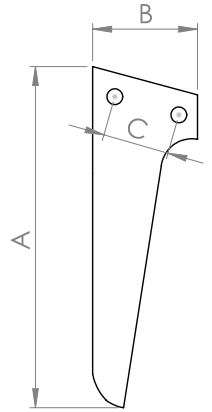

ÜRÜN KODU	ÜRÜN İSMİ	A	B	C	D	DELİK ÇAPI(mm)	KALINLIK(mm)
PRODUCT CODE	PRODUCT NAME	mm	mm	mm	mm	HOLE DIAMETER(mm)	THICKNESS(mm)
IK-YD-30-32222	İKİLER LEMKEN ARKA PARÇA (RIGHT-LEFT)	502	149	212	136	14	10
IK-YD-30-32223	İKİLER LEMKEN AŞINMA PARÇASI (RIGHT-LEFT)	284	237	161	156	14	7
IK-YD-30-32224	İKİLER LEMKEN DİK FREZE (RIGHT-LEFT)	290	112,5	70	-	16,5	12
IK-YD-30-32225	İKİLER LEMKEN KISA TABAN (RIGHT-LEFT)	422	120	154,4	61	14	10
IK-YD-30-32226	İKİLER LEMKEN ÖN PARÇA (RIGHT-LEFT)	341	97	137	54	14	12

## 2 Soles / Tabanlar



IK-YD-30-32168



IK-YD-30-32169

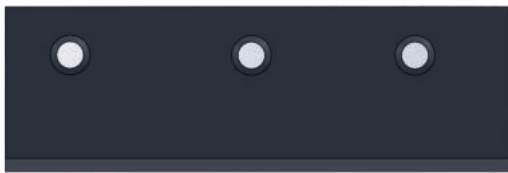
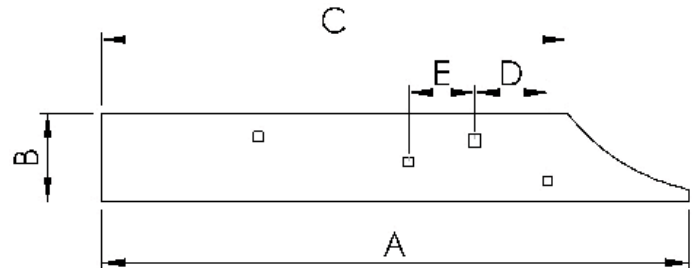
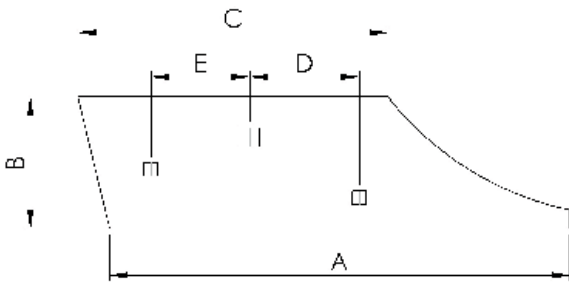

WELGER STOJECI / IK-YD-30-32249

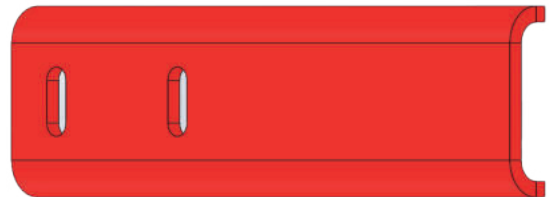

NASTAVAK DASKE IMT 755 - 6  
IK-YD-30-32251

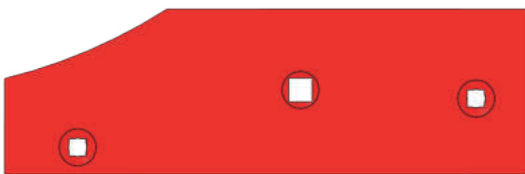

PLAZ IMT 757 KRACI - PREDNJI DEO  
IK-YD-30-34010



PLAZ IMT 757 DUZI - ZADNJI DEO SA PETOM  
IK-YD-30-34011

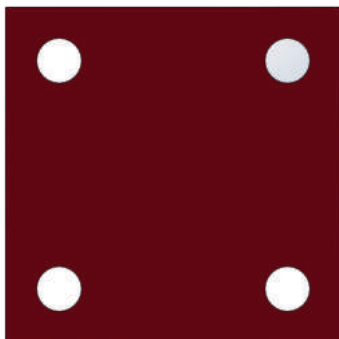

VEZNA PLOCA ZA DASKU I RAONIK  
IK-YD-30-32248

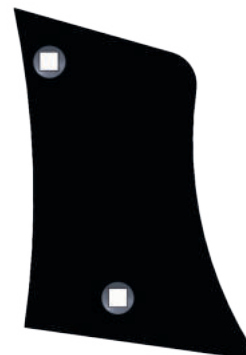

UMETAK - GRUD DASKE LEOPARD  
IK-YD-30-32247



PLAZ ZADNJI-  
DUZI VELIKI LESKOVACKI  
IK-YD-30-32237



PLAZ LEOPARD  
KRIVA GREDA ZADNJI DEO  
IK-YD-30-32235



PLAZ PREDNJI-  
KRACI VELIKI LESKOVACKI  
IK-YD-30-32236

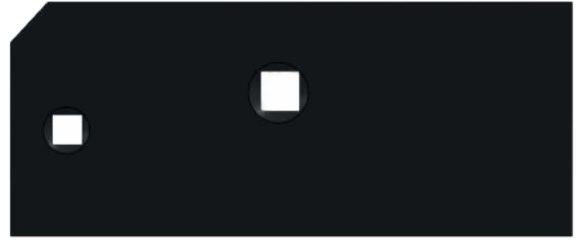

PLAZ LEOPARD  
KRIVA GREDA PREDNJI DEO  
IK-YD-30-34013



PETA PLAZA LEOPARD KRIVA GREDA  
IK-YD-30-34012

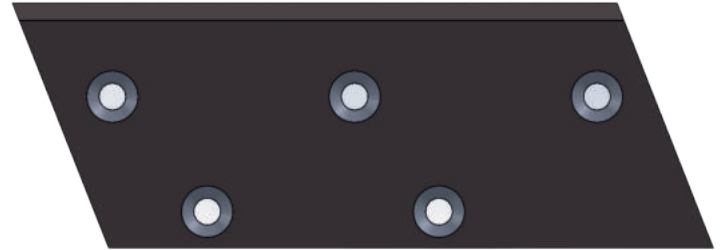

POLJOSTOJ - CLASS DOMINANT  
IK-YD-30-32238

ÜRÜN KODU	ÜRÜN İSMİ	A	B	C	D	E	DELİK ÇAPI(mm)	KALINLIK(mm)
PRODUCT CODE	PRODUCT NAME	mm	mm	mm	mm	mm	HOLE DIAMETER(mm)	THICKNESS(mm)
IK-YD-30-32169	IMT-755-6 UZUN TABAN DEMİR (RIGHT-LEFT)	801	120	635	100	90	13	12
IK-YD-30-32168	IMT-755-6 KISA TABAN DEMİR (RIGHT-LEFT)	420	120	283	100	90	13	12

# Disc Harrow

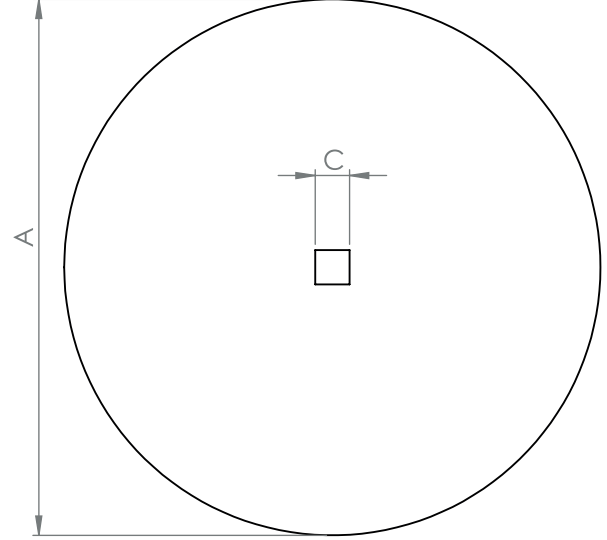
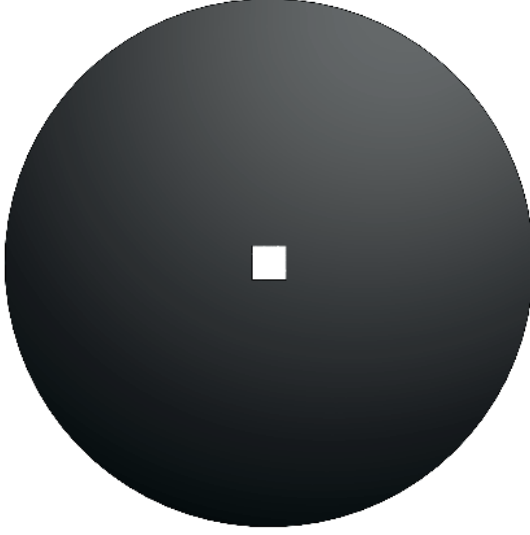

ÜRÜN KODU	ÜRÜN İSMİ	A	B	C	KALINLIK(mm)
PRODUCT CODE	PRODUCT NAME	mm	mm	mm	THICKNESS(mm)
İK-DH-10-10001	DÜZ DISKARO 460 (18")	460	51	26	3.5
İK-DH-10-10002	DÜZ DISKARO 460 (18")	460	51	31	3.5
İK-DH-10-10003	DÜZ DISKARO 510 (20")	510	59	67	4.0
İK-DH-10-10004	DÜZ DISKARO 510 (20")	510	59	31	3.5
İK-DH-10-10005	DÜZ DISKARO 510 (20")	510	59	26.5	3.5
İK-DH-10-10006	DÜZ DISKARO 510 (20")	510	56	36	4.0
İK-DH-10-10007	DÜZ DISKARO 510 (20")	510	59	26	4.0
İK-DH-10-10008	DÜZ DISKARO 560 (22")	560	71	67	4.5
İK-DH-10-10009	DÜZ DISKARO 560 (22")	560	68	36	4.5
İK-DH-10-10010	DÜZ DISKARO 560 (22")	560	71	31	4.5
İK-DH-10-10011	DÜZ DISKARO 560 (22")	560	71	36	4.5
İK-DH-10-10012	DÜZ DISKARO 610 (24")	610	86	67	5.0
İK-DH-10-10013	DÜZ DISKARO 610 (24")	610	86	41	5.0
İK-DH-10-10014	DÜZ DISKARO 610 (24")	610	86	31	5.0
İK-DH-10-10015	DÜZ DISKARO 660 (26")	660	97	44	6.0
İK-DH-10-10016	DÜZ DISKARO 710 (28")	710	102	41	6.0

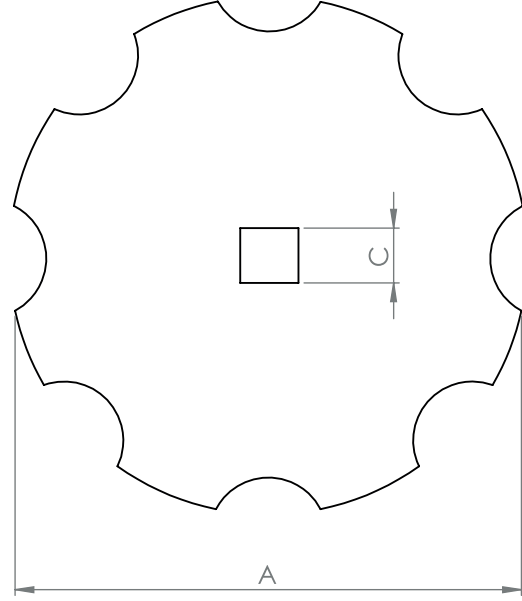
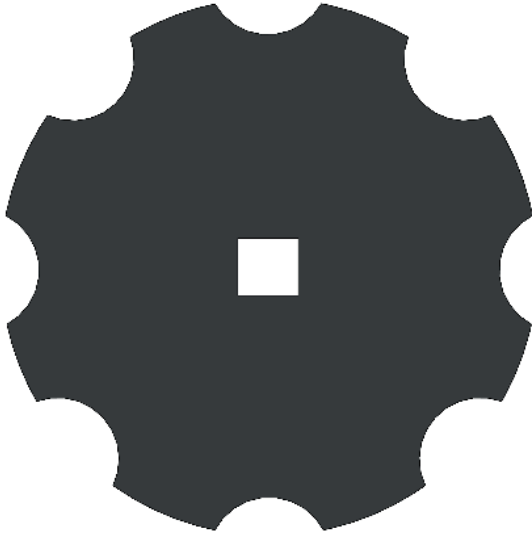

ÜRÜN KODU	ÜRÜN İSMİ	A	B	C	DELİK TİPİ	KALINLIK(mm)
PRODUCT CODE	PRODUCT NAME	mm	mm	mm	HOLE TYPES	THICKNESS(mm)
İK-DH-10-10017	Dişli Diskaro 460 (18")	460	51	21.5	KARE	3.5
İK-DH-10-10018	Dişli Diskaro 510 (20")	510	59	67	KARE	4
İK-DH-10-10019	Dişli Diskaro 510 (20")	510	59	31	KARE	3.5
İK-DH-10-10020	Dişli Diskaro 510 (20")	510	56	36	KARE	4
İK-DH-10-10021	Dişli Diskaro 510 (20")	510	59	31	KARE	4
İK-DH-10-10022	Dişli Diskaro 510 (20")	510	59	26.5	KARE	4
İK-DH-10-10023	Dişli Diskaro 560 (22")	560	71	67	ALTIGEN	4.5
İK-DH-10-10024	Dişli Diskaro 560 (22")	560	68	36	KARE	4.5
İK-DH-10-10025	Dişli Diskaro 560 (22")	560	71	31	KARE	4.5
İK-DH-10-10026	Dişli Diskaro 560 (22")	560	71	26	KARE	4.5
İK-DH-10-10027	Dişli Diskaro 610 (24")	610	86	67	ALTIGEN	5
İK-DH-10-10028	Dişli Diskaro 610 (24")	610	86	41	KARE	5
İK-DH-10-10029	Dişli Diskaro 610 (24")	610	86	31	KARE	5
İK-DH-10-10030	Dişli Diskaro 660 (26")	660	97	31	KARE	6
İK-DH-10-10031	Dişli Diskaro 710 (28")	710	102	41	KARE	6